

Izgled držača razmaka cijevi i način postavljanja

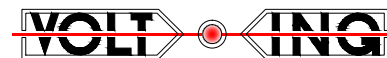
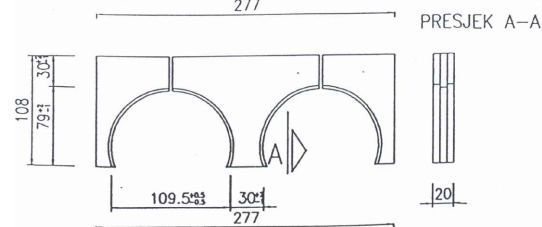
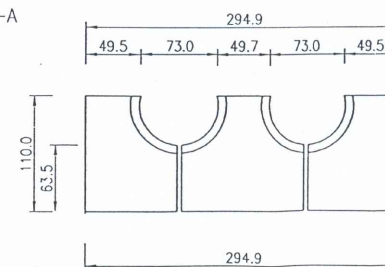
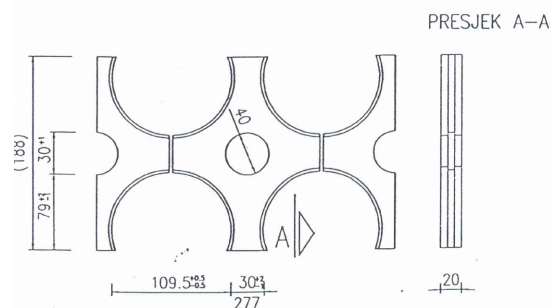
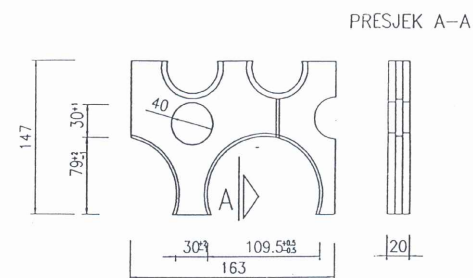
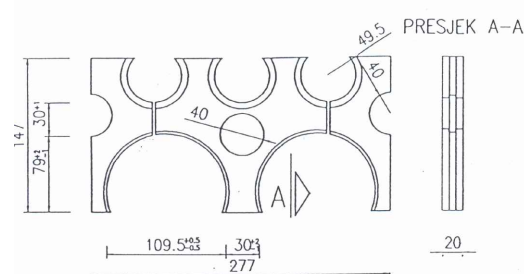
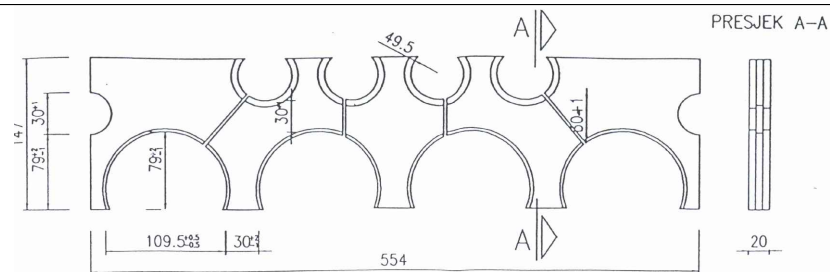

MLADEN ŽANIĆ
dipl.ing.el.
E 394 Ovlašteni inženjer
ELEKTROTEHNIKE

GRAĐEVINA:	IZGRADNJA NEKATEGORIZIRANE PROMETNICE U NASELJU MASLINICA NA OTOKU ŠOLTA	INVESTITOR:	OPĆINA ŠOLTA Podkuća 8 21430 GROHOTE OIB: 38621571773
SADRŽAJ:	DRŽAČI RAZMAKA CIJEVI (ČEŠLJEVI)	RAZINA RAZRADE:	GLAVNI PROJEKT
		STRUK. ODREDNICA:	ELEKTROTEHNIČKI PROJEKT
		NAZIV PROJEKTA:	JAVNA RASVJETA I EKI
		SURADNIK:	IVAN ŽANIĆ, spec.ing.aedif. <i>Ivan Žanić</i>
PROJEKTANT:	MLADEN ŽANIĆ, dipl.ing.el. <i>Mladen Žanić</i>	SURADNIK:	JOŠKO ŽANIĆ, dipl.ing.el. <i>Joško Žanić</i>
T.D.:	E-52/18	Z.O.P.: MASLINICA-GP	MAPA: 3./3
		DATUM:	03.2018.
		MJERILO:	NACRT br.: 18