

Uzdužni presjek

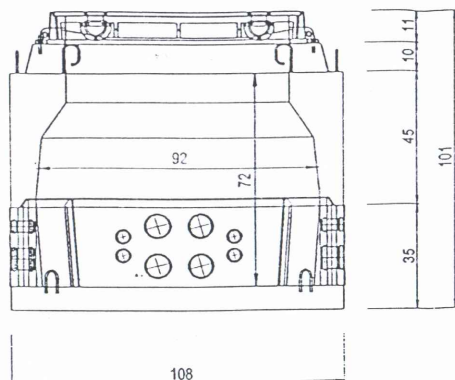

Raspored ulaznih ploča u elementima:

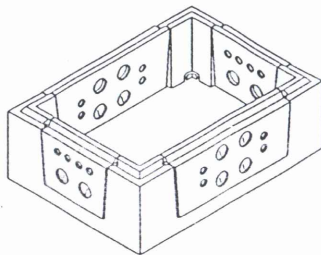

Uvodna ploča G75/40-4/4 (2 kom)

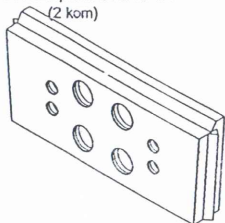

Uvodna ploča S75/40-2/4 (2 kom)

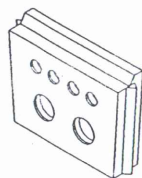

Napomena: U otvore PVC ulaznica u ulaznim pločama se ulažu PVC štitnici, kako je naznačeno na prostornom prikazu

PVC štitnici



Donji dio

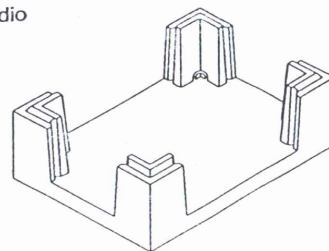

Poklopac

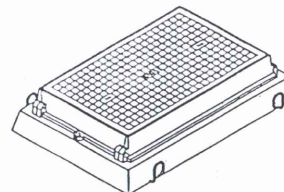

Prostorni prikaz

Gornji dio

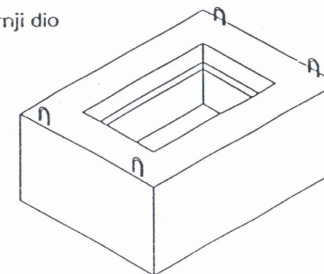

Poprečni presjek

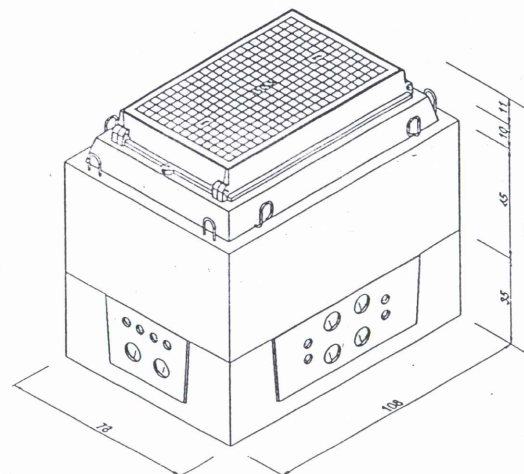
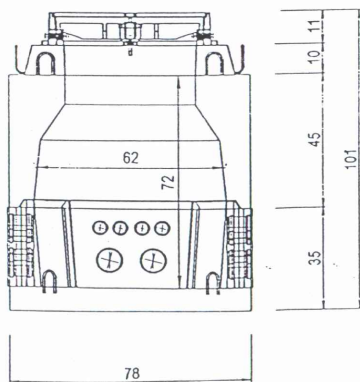

TIPSKI MONTAŽNI ZDENAC TIP MZ D1

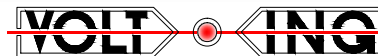

MLADEN ŽANIĆ
dipl.ing.el.

E 394

OVLAŠTENI INŽENJER
ELEKTROTEHNIKE

GRAĐEVINA:	IZGRADNJA NEKATEGORIZIRANE PROMETNICE U NASELJU MASLINICA NA OTOKU ŠOLTA	INVESTITOR:	OPĆINA ŠOLTA Podkuća 8 21430 GROHOTE OIB: 38621571773			
SADRŽAJ:	TIPSKI MONTAŽNI ZDENAC TIP MZ D1	RAZINA RAZRADE:	GLAVNI PROJEKT			
		STRUK. ODREDNICA:	ELEKTROTEHNIČKI PROJEKT			
		NAZIV PROJEKTA:	JAVNA RASVJETA I EKI			
PROJEKTANT:	MLADEN ŽANIĆ, dipl.ing.el. <i>Žanić</i>	SURADNIK:	IVAN ŽANIĆ, spec.ing.aedif. <i>Žanić</i>			
T.D.:	E-52/18	Z.O.P.: MASLINICA-GP	MAPA: 3./3	DATUM: 03.2018.	MJERILO:	NACRT br.: 20